



IR-710 / IR-711UB

Industrial Cellular VPN Router

User's Manual

Version 1.1

May, 2012

www.oring-networking.com



COPYRIGHT NOTICE

Copyright © 2011 ORing Industrial Networking Corp.

All rights reserved.

No part of this publication may be reproduced in any form without the prior written consent of ORing Industrial Networking Corp.

TRADEMARKS



is a registered trademark of ORing Industrial Networking Corp.

All other trademarks belong to their respective owners.

REGULATORY COMPLIANCE STATEMENT

Product(s) associated with this publication complies/comply with all applicable regulations.

Please refer to the Technical Specifications section for more details.

WARRANTY

ORing warrants that all ORing products are free from defects in material and workmanship for a specified warranty period from the invoice date (5 years for most products). ORing will repair or replace products found by ORing to be defective within this warranty period, with shipment expenses apportioned by ORing and the distributor. This warranty does not cover product modifications or repairs done by persons other than ORing-approved personnel, and this warranty does not apply to ORing products that are misused, abused, improperly installed, or damaged by accidents.

Please refer to the Technical Specifications section for the actual warranty period(s) of the product(s) associated with this publication.

DISCLAIMER

Information in this publication is intended to be accurate. ORing shall not be responsible for its use or infringements on third-parties as a result of its use. There may occasionally be unintentional errors on this publication. ORing reserves the right to revise the contents of this publication without notice.

CONTACT INFORMATION

ORing Industrial Networking Corp.

3F., No.542-2, Zhongzheng Rd., Xindian Dist., New Taipei City 23148, Taiwan (R.O.C.)

Tel: +886-2-2218-1066 // Fax: +886-2-2218-1014

Website: www.oring-networking.com

Technical Support

E-mail: support@oring-networking.com

Sales Contact

E-mail: sales@oring-networking.com (Headquarters)

sales@oring-networking.com.cn (China)



Tables of Contents

Getting to Know your Router	1
1.1 Overview	1
1.2 Software Features	1
1.3 Hardware Features	1
Hardware Installation.....	2
2.1 DIN-Rail Installation	2
2.2 Wall-Mounted Installation.....	3
2.3 SIM Card Installation (IR-710 only).....	4
2.4 3G USB Modem Installation (IR-711UB only)	4
Hardware Overview.....	5
3.1 Front Panel.....	5
3.2 Front Panel LEDs	6
Cables and Antenna.....	7
4.1 Ethernet Cables.....	7
4.2 10BASE-T/100BASE-T(X) Pin Assignments.....	7
4.3 Wireless Antenna (IR-710 only).....	8
Management Interface	9
5.1 First-time Installation.....	9
5.2 Router Configuration.....	10
5.3 Main Interface.....	11
5.3.1 Basic Setting	11
WAN.....	11
LAN	13
DHCP	13
5.3.2 Advanced Settings.....	15
NAT Setting	15
Security Setting.....	18
VPN Setting.....	19
Routing Protocol (Routing Setting)	26
Miscellaneous DDNS	29
Miscellaneous SNMP	30
5.3.3 System Tools.....	31
Date & Time.....	31
System Event	32
Login Setting.....	32
Router Restart	33
Firmware Upgrade	33



Save/Restore Configurations	34
Remote management	35
Miscellaneous (Ping).....	35
5.3.4 System Status	36
System Info.....	36
System Log.....	36
Traffic Statistics.....	37
Technical Specifications	38

Getting to Know your Router

1.1 Overview

The ORing IR-710 / IR-711UB router is designed to operate in industrial environment. The router provides a fast and effective ways of communicating to the internet over wired LAN.

With built-in HSUPA WAN connection (IR-710) or an external USB modem (IR-711UB), the ORing IR-710 / IR-711UB router can be mounted in harsh environment easily to provide internet access anytime and anywhere.

The ORing IR-710 / IR-711UB router's VPN capability creates encrypted "Virtual Tunnels" through the internet, allowing remote or traveling users for secured connection with the network in your office.



1.2 Software Features

- Secured Management by HTTPS
- Intuitive Web-based management user interface for simply and easily operation.
- Functions of firewall provides many security features such as blocking attacks from hacker, especially IP Spoofing, Ping flood, Ping of Death, DoS, DRDoS, Stealth Scan, etc.
- Advanced firewall configuration to extend the capability and security, such as Virtual Server, Port Trigger, DMZ host, UPnP auto Forwarding, IP Filter and MAC filter.
- Event Warning by Syslog, Email, SNMP Trap, Relay and Beeper

1.3 Hardware Features

- Built-in HSUPA Cellular Modem with SIM card slot included for WAN connection (IR-710)
- USB port for installing user-selectable 3G USB modem for WAN connection (IR-711UB)
- 10/100Base-T(X) Ethernet ports for LAN connection individually.
- Power Inputs: 12~48 VDC
- Casing: IP-30
- Operating Temperature: -10 to 55°C
- Storage Temperature: -40 to 85°C
- Operating Humidity: 5% to 95%, non-condensing

Hardware Installation

2.1 DIN-Rail Installation

IR-710 / 711UB has DIN-Rail Kit on rear panel. The DIN-Rail kit helps AP to fix on the DIN-Rail. It is easy to install the router on the DIN-Rail.

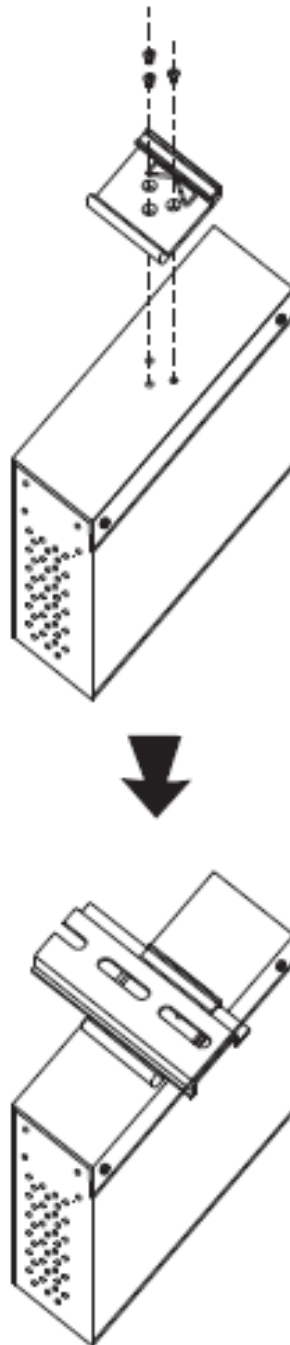

2.2 Wall-Mounted Installation

IR-710 / 711UB has another installation method to secure the router. A wall mount panel can be found in the package.

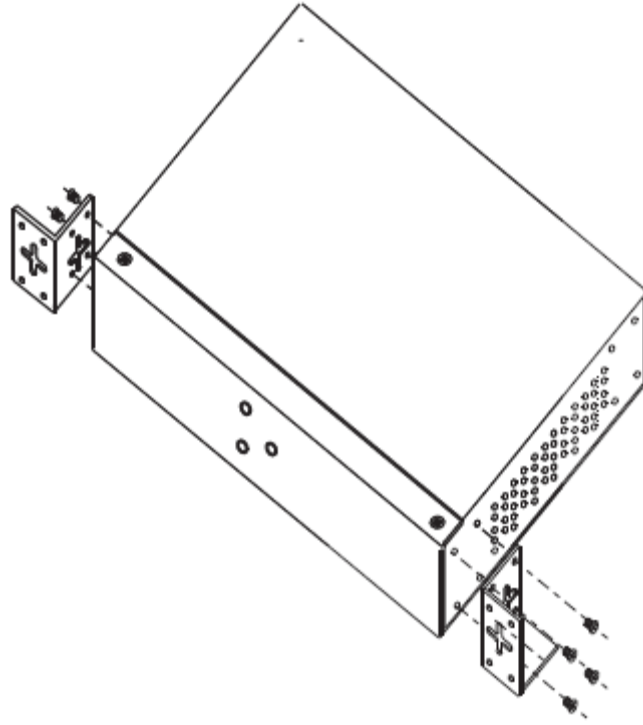

2.3 SIM Card Installation (IR-710 only)

With IR-710 POWERED DOWN :

1. Un-fasten the screws.
2. Remove the cover.
(NOTE : The cover removal is only for SIM card installation. DO NOT remove the cover in normal operation.)
3. Install SIM card into its slot.
4. Replace the cover.
5. Fasten the screws.

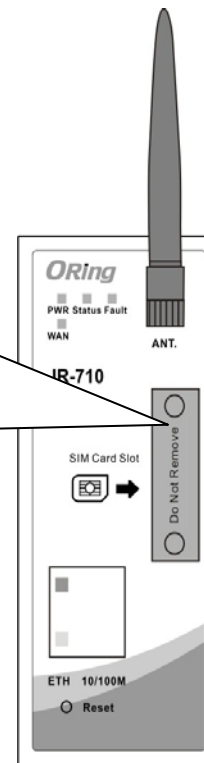

Important Notice: POWER DOWN THE IR-710 BEFORE INSTALLING SIM CARD.

2.4 3G USB Modem Installation (IR-711UB only)

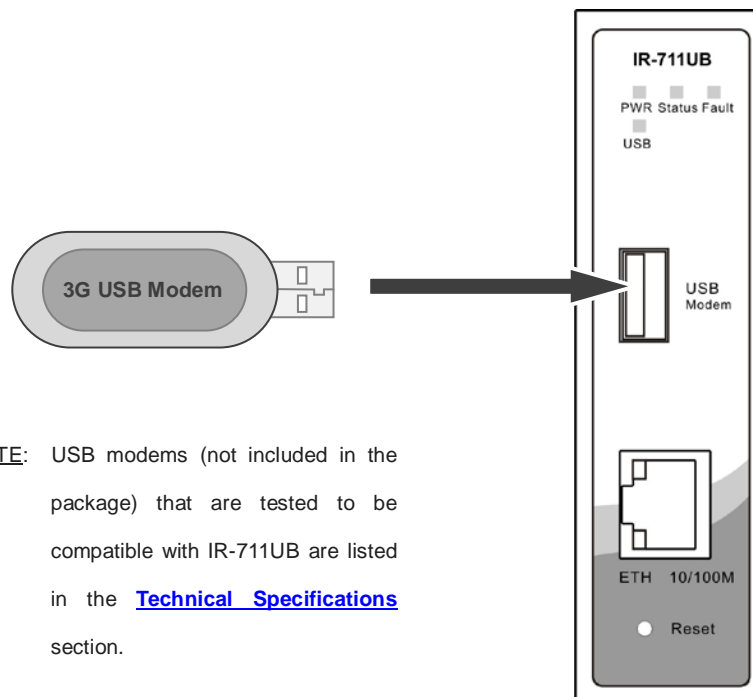

NOTE: USB modems (not included in the package) that are tested to be compatible with IR-711UB are listed in the [Technical Specifications](#) section.

Hardware Overview

3.1 Front Panel

The following table describes the labels that stick on the IR-710 / IR-711UB

Port	Description
10/100 Base-T(X) Fast Ethernet Ports	10/100Base-T(X) fast Ethernet ports support auto-negotiation. Default Setting : Speed: auto





1. LED for PWR. When the PWR links, the green LED will light On.
2. LED for USB modem status (IR-711UB only)
3. USB port for 3G USB modem connection LED for Ethernet ports link status (IR-711UB only)
4. Reset button. Push the button 5 seconds for factory default.
5. LED for Fault Relay. When the fault occurs, the red LED will light On.
6. LED for Status. When the system is ready, the green LED will light On.
7. LED for WAN. When the cellular modem link up, the green LED will light On (IR-710 only).
8. LED for Ethernet port active
9. 10/100Base-T(X) RJ45 fast Ethernet port
10. LED for Ethernet ports speed
11. 850/900/1800/2100MHz antenna for internal HSUPA modem (IR-710 only)
12. Cellular Modem with SIM card slot (IR-710 only)

3.2 Front Panel LEDs

LED	Color	Status	Description
PWR	Green	Green On	DC power activated.
Status	Green	Green On	Power is On.
		Green Blinking	Booting up
WAN	Green	Green On	Modem Ready
		Green Blinking	Checking Modem status
Fault	Red	Red On	Fault relay. Power failure or Port down/fail.
10/100Base-T(X) Fast Ethernet Ports			
10Base-T	Amber	Amber On	Port speed to 10Base-T
100Base-T(X)	Green	Green On	Port speed to 100Base-TX

Cables and Antenna

4.1 Ethernet Cables

The IR-710 / IR-711UB router has one 10/100Base-T(X) Ethernet ports. According to the link type, use CAT 3, 4, 5,5e UTP cables to connect to any other network device (PCs, servers, switches, routers, or hubs). Please refer to the following table for cable specifications.

Cable Types and Specifications

Cable	Type	Max. Length	Connector
10Base-T	Cat. 3, 4, 5 100-ohm	UTP 100 m (328 ft)	RJ45
100Base-T(X)	Cat. 5 100-ohm UTP	UTP 100 m (328 ft)	RJ45

4.2 10BASE-T/100BASE-T(X) Pin Assignments

With 10Base-T/100Base-T(X) cable, pins 1 and 2 are used for transmitting data, and pins 3 and 6 are used for receiving data.

RJ45 Pin Assignments

Pin Number	Assignment
1	TD+
2	TD-
3	RD+
4	Not used
5	Not used
6	RD-
7	Not used
8	Not used

The IR-710 / 711UB routers supports auto MDI/MDI-X operation. You can use a straight-through cable to connect PC and AP. The following table below shows the 10Base-T/ 100Base-T(X) MDI and MDI-X port pin outs.

MDI/MDI-X pins assignment

Pin Number	MDI port	MDI-X port
1	TD+(transmit)	RD+(receive)
2	TD-(transmit)	RD-(receive)
3	RD+(receive)	TD+(transmit)
4	Not used	Not used
5	Not used	Not used
6	RD-(receive)	TD-(transmit)
7	Not used	Not used
8	Not used	Not used

Note: "+" and "-" signs represent the polarity of the wires that make up each wire pair.

4.3 Wireless Antenna (IR-710 only)

850/900/1800/2100MHz antenna is used for built-in HSUPA modem. External RF cable and antenna also can be applied with this connector.



Cellular Antenna (IR-710 only)

Management Interface

5.1 First-time Installation

Before installing IR-710 / IR-711UB router, you need to access the router by a computer equipped with an Ethernet card. Using an Ethernet card to connect to LAN port is easier and is recommended.



Basic connection for IR-710 / IR-711UB

Step 1: Select the Power Source

IR-710/IR711UB router can be powered by +12~48V DC power input.

Step 2: Connect a computer to IR-710/IR711UB

Use either an Ethernet cable to connect to ETH of IR-710/IR711UB router to a computer. If the LED of the LAN port lights up, it indicates the connection is established. After that, the computer will initiate a DHCP request to get an IP address from the router.

Step 3: Use the web-based manager to configure IR-710/IR711UB

The default gateway IP of IR-710/IR711UB router is 192.168.10.1. Start the web browser of your computer and type <http://192.168.10.1> in the address box to access the webpage. A login window will popup, and then enter the default login name **admin** and password **admin**.

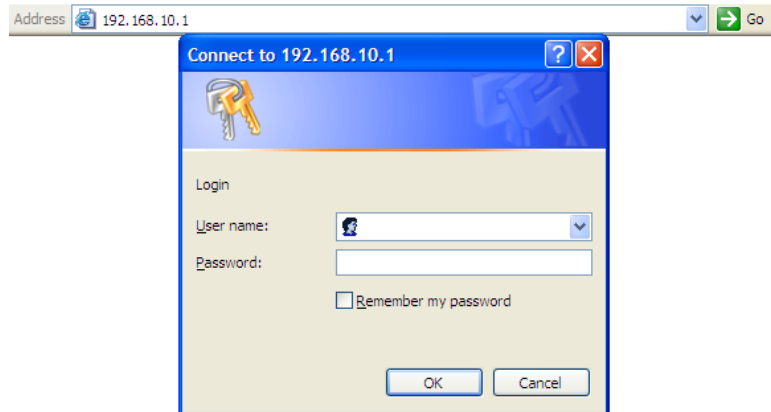

Login screen

5.2 Router Configuration

In this section, the web management page will be explained in detail.

With default setting, you can type <http://192.168.10.1> in the address box of web browser to login the web management interface. A login window will be prompted, enter username **admin** & password **admin** to login.

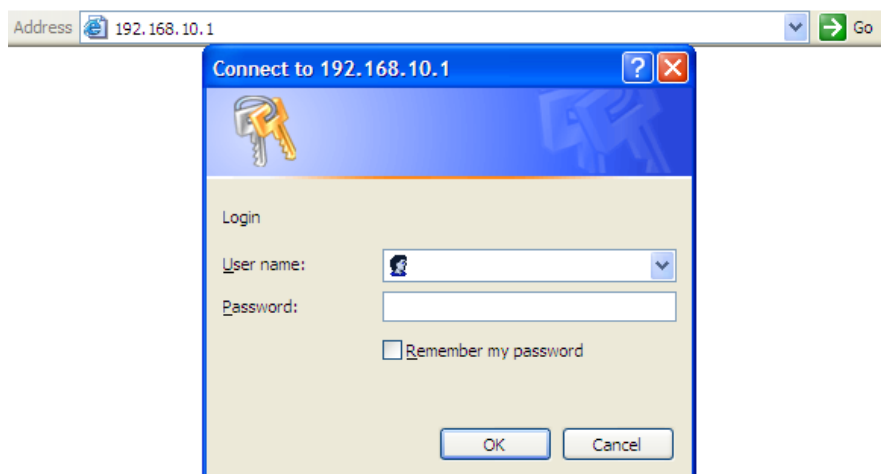

Login screen

For security reasons, we strongly recommend you to change the password. Click on **System Tools > Login Setting** and change the password.

5.3 Main Interface

The **Home** screen will be shown when login successfully.

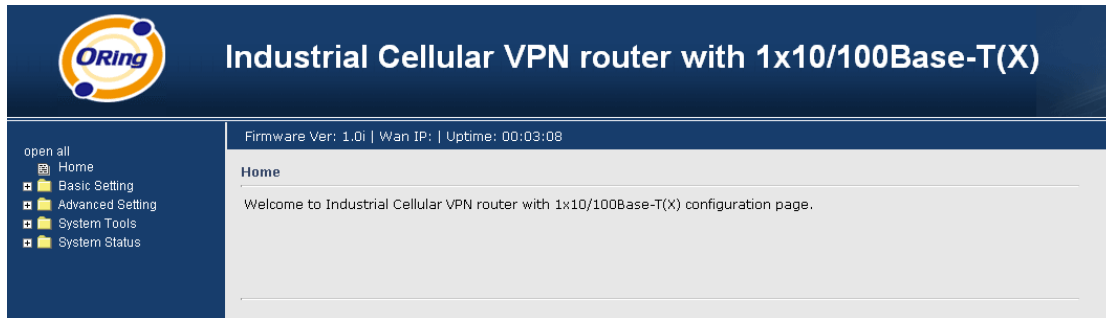

Main Interface

In the page, you can check the Firmware version, the router running time and the WAN IP setting.

The following table describes the labels in this screen.

Label	Description
Firmware	Show the current firmware version.
Uptime	Show the elapsed time since the AP router is started.
Wan IP	Show the WAN IP address.

5.3.1 Basic Setting

WAN

The IR-710 / IR-711UB router provides Modem/3G connection.

WAN Connection Type: Modem / 3G

For using this type of connection, use the built-in HSUPA modem.

Basic Setting --> WAN

WAN Settings.

Phone Number:

APN:

User Name:

Password:

Baud Rate:

PIN: Enable PIN check before dialing
PIN Code:

Auto Connect : Enable

Reconnect on Failure: Enable

Fast Mode: Enable

Device Status : Ready.

Operations :

Link Status : Disconnected

Modem Status: Operator:
RadioType:
Signal Quality:

Auto recheck: 00h : 00m : 00s

Modem/3G Screen

The following table describes the labels in this screen.

Label	Description
Phone Number	Telephone number provided by your ISP.
APN	Enter the APN value it is optional
User Name	User name provided by your ISP.
Password	Password provided by your ISP.
PIN	Enter the PIN code if PIN check is required.
Auto Connect	If this option is enabled, the connection will be called up when router boots up.
Device Status	Show the status of built-in HSUPA modem device.
Operations	Click " Connect " to call up the built-in HSUPA modem. Click " Disconnect " to shut down the connection.
Link Status	Show the status of connection, up , down or connecting .
Auto recheck	Enable auto refresh modem status per 28 sec

LAN

These are the IP settings of the LAN interface for the IR-710 / IR-711UB router. The LAN IP address is privately for your internal network and cannot be exposed on the Internet.

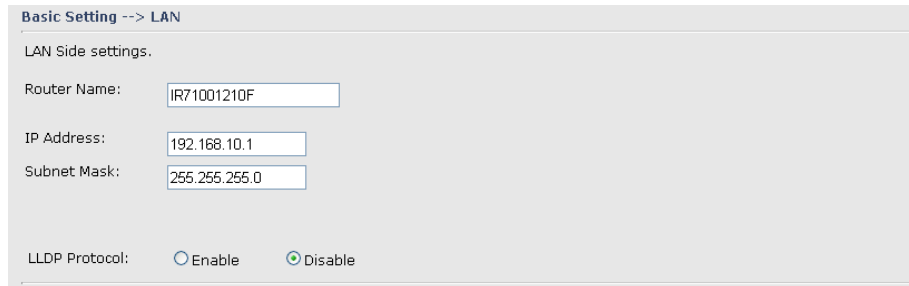

LAN Screen

The following table describes the labels in this screen.

Label	Description
IP Address	The IP address of the LAN interface, the default IP address is 192.168.10.1
Subnet Mask	The Subnet Mask of the LAN interface, the default Subnet mask is 255.255.255.0
LLDP Protocol	Enable/Disable LLDP function

DHCP

DHCP stands for Dynamic Host Control Protocol. The IR-710 / IR-711UB was built-in DHCP server. The internal DHCP server will assign an IP address to the computers (DHCP client) on the LAN automatically.

Set your computers to be DHCP clients by setting their TCP/IP settings to obtain an IP address automatically. The DHCP server will allocate an unused IP address from the IP address pool to the requesting computer automatically.

1. DHCP Sever

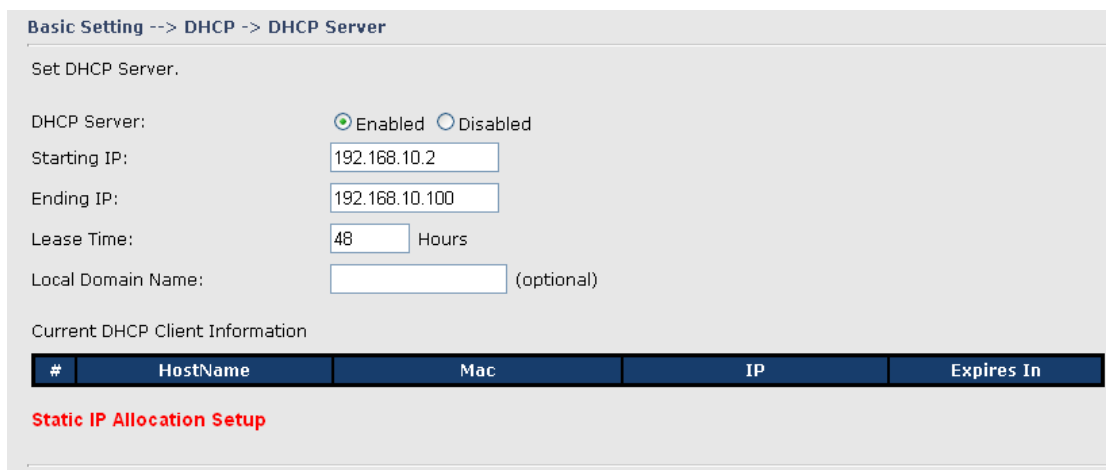

DHCP Server Screen

The following table describes the labels in this screen.

Label	Description
DHCP Server	Enable or Disable the DHCP Server. The default setting is Enable
Starting IP	The starting IP address of the IP range for the DHCP server
Ending IP	The ending IP address of the IP range for the DHCP server
Lease Time	The period of time for the IP to be leased. Enter the Lease time. The default setting is 48 hours.
Local Domain Name	Enter the local domain name of private network. It is optional.
Current DHCP Client Information	List of the computers on your network that are assigned an IP address by internal DHCP server.

2. IP Allocation

The IP Allocation provides one-to-one mapping of MAC address to IP address. When computers with the MAC address requesting an IP from the IR-710 / IR-711UB router, it will be assigned with the IP address according to the mapping. You can choose one from the client lists and add it to the mapping relationship.

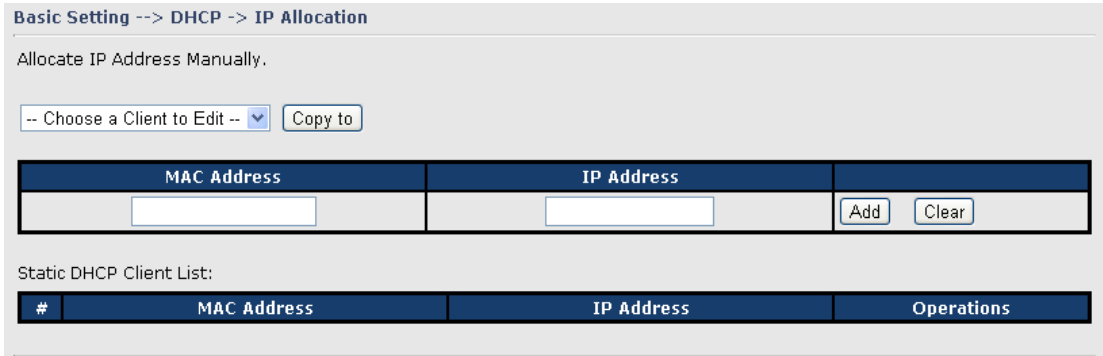

IP Allocation Screen

The following table describes the labels in this screen.

Label	Description
Choose a Client to Edit	The list shows the MAC addresses and IP addresses that are already assigned by IR-710 / IR-711UB. Choose one from the list and click Copy to button for editing.
MAC Address	The MAC addresses of the computer.
IP Address	The IP address to be related to the MAC address.
Static DHCP Client List	The list shows the MAC address and IP address one-to-one relationship.

5.3.2 Advanced Settings

NAT Setting

1. Virtual Server

Virtual Server is used for setting up public services on the LAN, such as DNS, FTP and Email. Virtual Server is defined as a Local Port to the LAN servers, and all requests from Internet to this Local port will be redirected to the computer specified by the Local IP. Any PC that was used for a virtual server must have static or reserved IP Address because its IP address may change when requesting IP by DHCP.

Advanced Setting --> NAT Setting -> Virtual Server

Virtual server settings.

Virtual Server: Enable Disable

Description:

Public IP: All Specify

Public Port:

Protocol: TCP UDP Both

Local IP:

Local Port:

Enable Now: Yes No

Virtual server list:

#	Description	Public IP	Public Port	Protocol	Local IP	Local Port	Enabled	Ops

Virtual Server

The following table describes the labels in this screen.

Label	Description
Virtual Server	Enable or disable Virtual Server.
Description	Enter the description of the entry. Acceptable characters consist of '0-9', 'a-z', 'A-Z'. This field accepts null value.
Public IP	Enter the public IP that is allowed to access the virtual service, if not specified, choose All.
Public Port	The port number on the WAN (Wide Area Network) side that will be used to access the virtual service.
Protocol	The protocol used for the virtual service.
Local IP	The IP of the computer that will be providing the virtual service.
Local Port	The port number of the service used by the Private IP computer.
Enable Now	Enable the virtual server entry after adding it.
Virtual server list	Click Edit to edit the virtual service entry, Del to delete the entry.

2. Port Trigger

Some applications require multiple connections, like Internet games, video conferencing, Internet calling and so on. These applications cannot work with a pure NAT router. Port Trigger is used for some of the applications that can work with an NAT router.

Advanced Setting --> NAT Setting -> Port Trigger

Port Trigger settings.

Port Trigger: Enable Disable

Description:

Trigger Port:

Trigger Protocol: TCP UDP Both

Incoming Port:

Incoming Protocol: TCP UDP Both

Enable: Yes No

Port Trigger List:

#	Description	Trigger Protocol	Trigger Port	Incoming Protocol	Incoming Port	Enable	Ops
---	-------------	------------------	--------------	-------------------	---------------	--------	-----

Port Trigger Screen

The following table describes the labels in this screen.

Label	Description
Port Trigger	Enable or disable Port Trigger.
Description	This is the description for the entry.
Trigger Port	This is the port used to trigger the application.
Trigger Protocol	This is the protocol used to trigger the application.
Incoming Port	This is the port number on the WAN side that will be used to access the application.
Enable	Enable the rule after adding the entry.
Port Trigger List	Click Edit to edit the entry, click Del to delete the entry.

3. DMZ

It allows a computer to be exposed to the Internet. This feature is useful for gaming purposes.

Enter the IP address of the internal computer that will be the DMZ host. Adding a client to the DMZ may expose your local network with variety of security risks, so only use this option carefully.

Advanced Setting --> NAT Setting -> DMZ

DMZ settings.

DMZ: Enable Disable

Description:

DMZ Host IP:

DMZ Screen

The following table describes the labels in this screen.

Label	Description
DMZ	Enable or disable the DMZ.
Description	Description for the DMZ host entry.
DMZ Host IP	Enter the IP address of the computer to be in the DMZ.

4. UPnP

The UPnP (Universal Plug and Play) feature allows the devices, such as Internet computers, to access the local host resources or devices as needed. UPnP devices can be automatically discovered by the UPnP service application on the LAN.

Advanced Setting --> NAT Setting -> UPnP

UPnP settings.

UPnP: Enabled Disabled

Enable NAT-PMP

UPnP List:

#	Application	Ext Port	Protocol	Int Port	IP Address
---	-------------	----------	----------	----------	------------

UPnP Screen

The following table describes the labels in this screen.

Label	Description
UPnP	Enable or disable UPnP.
Enable NAT-PMP	NAT-PMP allows a computer in a private network (behind a NAT router) to automatically configure the router to allow parties outside the private network to contact with each other. NAT-PMP operates with UDP. It essentially automates the process of port forwarding. Check the box to enable NAT-PMP.
UPnP List	This table lists the current auto port forwarding information.

	<p>Application: The application that generates this port forwarding.</p> <p>Ext Port: The port opened on WAN side.</p> <p>Protocol: The protocol type.</p> <p>Int Port: The port redirected to the local computer.</p> <p>IP Address: The IP address of local computer to be redirected to.</p> <p>Status: This status shows if the entry is valid or not.</p>
--	--

Security Setting

1. IP Filter

Filters are used to deny or allow LAN computers from accessing the internet. It also allows or denies WAN hosts to access LAN computers.

Advanced Setting --> Security Setting -> IP Filter

IP filter settings.

IP Filter: Enable Disable

Description:

Rule:

Direction:

IP Address: Source IP: Destination IP:

Protocol: All ICMP Specify protocol number: TCP Specify port: UDP Specify port:

Enable Now: Yes No

IP filter list:

#	Description	Rule	Direction	Source IP	Destination IP	Protocol	Port	Enabled	Operations
---	-------------	------	-----------	-----------	----------------	----------	------	---------	------------

IP Filter Screen

The following table describes the labels in this screen.

Label	Description
IP Filter	Enable or disable the IP Filter.
Description	Enter description for the entry.
Rule	Select DROP , ACCEPT and REJECT rule for the entry.
Direction	Specify the direction of the data flow that is to be filtered.
IP Address	Enter the IP address of the source and destination computer.
Protocol	Choose which protocol to be filtered.

Enable Now	Enable the entry after adding it.
IP filter list	Click edit for editing the entry, click Del to delete the entry.

2. MAC Filter

Filters are used to deny or allow LAN computers from accessing the internet, according to their MAC address.

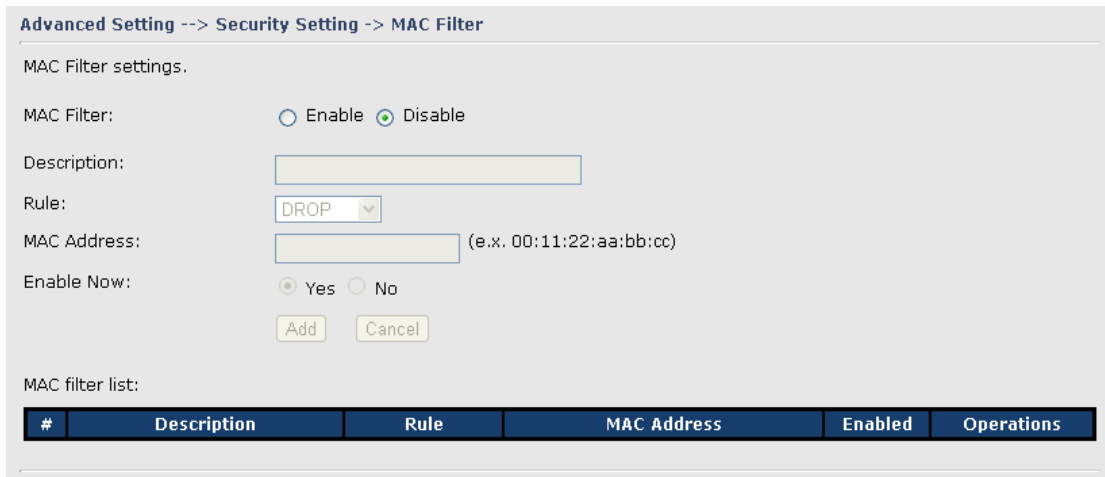

MAC Filter Screen

The following table describes the labels in this screen.

Label	Description
MAC Filter	Enable or disable the MAC Filter.
Description	Enter the description for the entry.
Rule	Select DROP , ACCEPT and REJECT rule for the entry.
MAC Address	Enter the MAC address to be filtered.
Enable Now	Enable the entry after adding it.
IP filter list	Click Edit for editing the entry, click Del to delete the entry.

VPN Setting

VPN Setting is settings that are used to create virtual private tunnels to remote VPN gateways. The tunnel technology supports data confidentiality, data origin, authentication and data integrity of network information by utilizing encapsulation protocols, encryption algorithms, and hashing algorithms.

1. Open VPN

Open VPN is a full-functioned SSL VPN solution which can accommodates a wide range of configurations including remote access, site-to-site VPNs, WiFi security, and

enterprise-scale remote access solutions with load balancing, failover, and fine-grained access-controls.

Advanced Setting --> Vpn Setting -> Openvpn

Openvpn settings.

Server settings.

Openvpn Server: Enable Disable

Tunnel Protocol:

Port:

LZO Compression: Enable Disable

Keys Setting:

Client settings.

Openvpn Client: Enable Disable

Server IP :

Tunnel Protocol:

Port:

LZO Compression: Enable Disable

Keys Setting:

Open VPN Screen

The following topology shows the common use of VPN connection from WAN side.

1: Open VPN Server

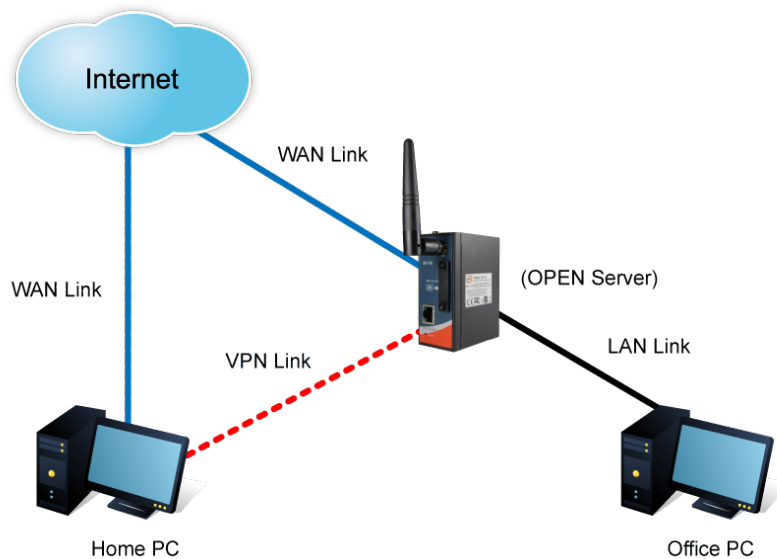

Connection to Open VPN Server

Before connecting to the Open VPN server of IR-710 / IR-711UB router, please install



Open VPN client software for your windows PC. It can be downloading from <http://OpenVPN.net/download.html#stable>. The current version of Open VPN used in IR-710 / IR-711UB is version 2.0.9. The corresponding software for client should be installed.

The following table describes the labels in this screen.

Label	Description
Open VPN Server	Enable or disable the function of Open VPN Server.
Tunnel Protocol	Select UDP or TCP protocol.
Port	Input the number about the port, and the default is 1194.
LZO Compression	Enable or disable the function of LZO Compression.
Keys Setting	Select Auto to use the preset certificates, select Manual to paste your certificates. Please install Open VPN client software to generate your certificates and paste them here. For more information, please visit Open VPN website.

2: Open VPN Client

Two routers are needed for creating site-to-site VPN connection using this mode.

The following table describes the labels in this screen.

Label	Description
Open VPN Client	Enable or disable the function of Open VPN Client. You can allow or deny the Open VPN Client with this option.
Server IP	Enter the Open VPN Server IP address.
Tunnel Protocol	Select UDP or TCP protocol.
Port	Enter the port number, default is 1194.
LZO Compression	Enable or disable the LZO Compression.
Keys Setting	Select Auto to use the preset certificates, select Manual to paste your certificates. Please install software for Open VPN client to generate your certificates and paste them here. For more information, please visit Open VPN website.

3: Open VPN Server VS Client

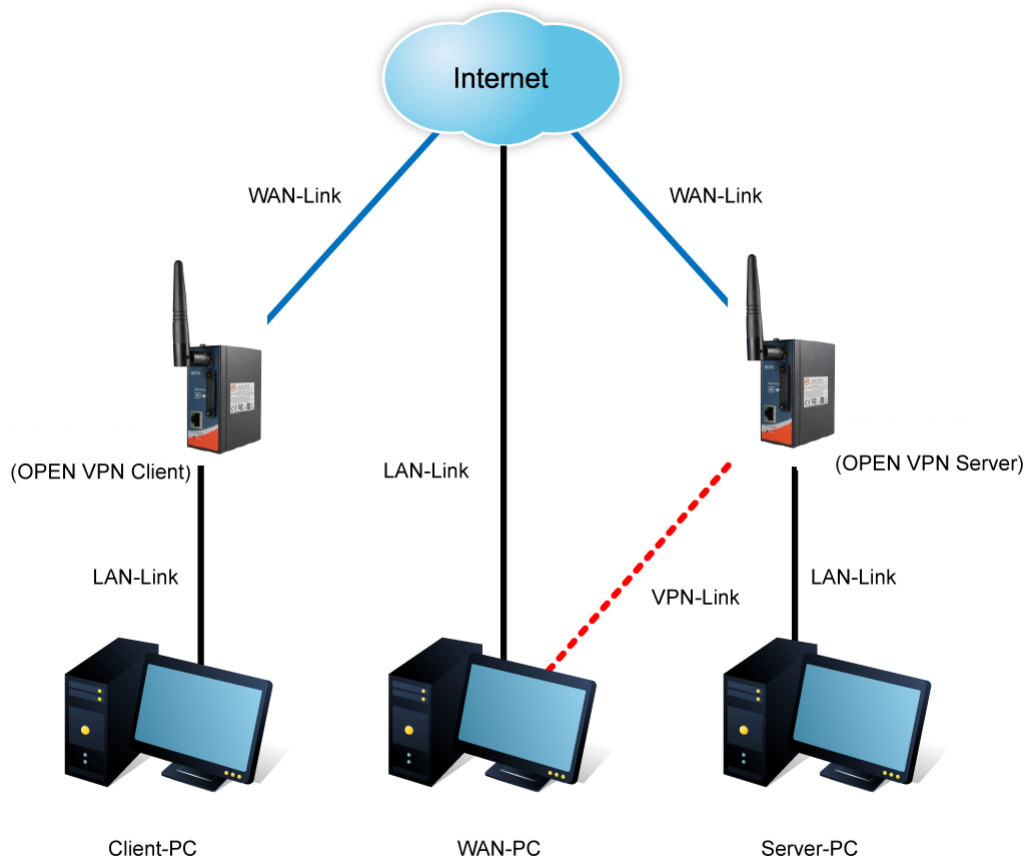

The chart above displays the connection of Open VPN Server and Client. The Server IP and Client IP address should configure with the same network domain.

2. PPTP VPN

The PPTP (Point to Point Tunneling Protocol) VPN feature allows PC connected to the router from WAN port, just like connecting in the LAN. To create a PPTP connection to the router, you should create a PPTP network connection if you are using a window PC. The steps are: **Right click Network > property > create a new connection > connect to my work space (VPN) > use VPN to internet > enter the user name and password** which are set in the page.

Advanced Setting --> Vpn Setting --> PPTP Vpn

PPTP Server settings.

PPTP Server: Enable Disable

Server IP:

Clients IP:

PPP Options:

- require-chap
- require-mschap
- require-mschap-v2
- require-mppe

Routing Option: Enable Routing Protocols through PPTP VPN Connection

CHAP-Secrets:

PPTP VPN Screen

The following topology shows the common use of PPTP connection from the internet.

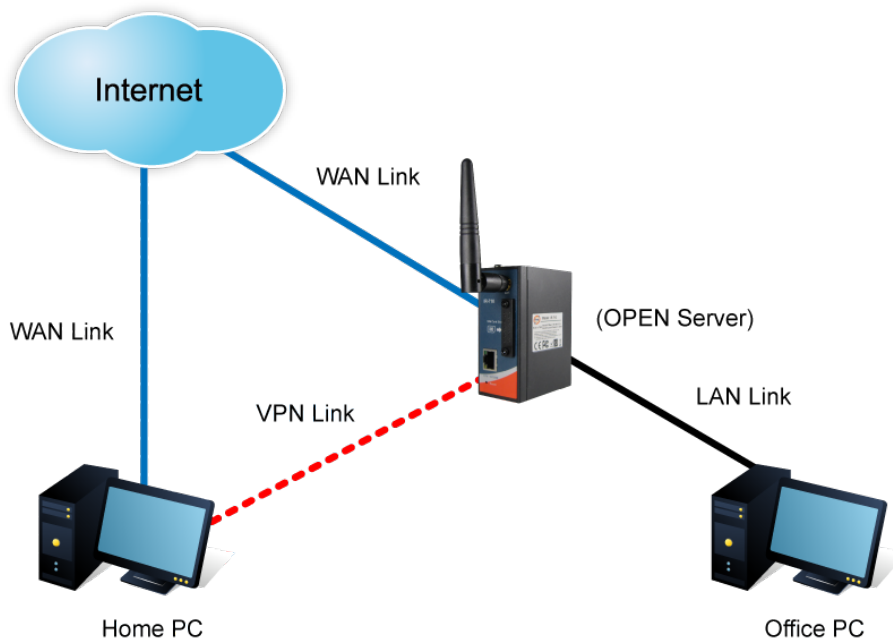

Connection to PPTP VPN Server

The following table describes the labels in this screen.

Label	Description
PPTP Server	Enable or disable PPTP VPN Server.
Server IP	Enter the server side IP address, default is the LAN port IP.
Client IP	Enter the IP address range, format is as 192.168.10.xx-xx ,

	connected client will be assigned the IP address.
CHAP-Secrets	Enter the username and password pairs, format is as user * pass *, multiple username password pairs are allowed.

3. PPTP Client

If the router A want to link with the others which is not in the same network with the router A, the function of PPTP client should support in the router page.

Advanced Setting --> Vpn Setting -> PPTP Client

PPTP Client settings.

PPTP Client: Enable Disable

Server IP/Hostname:

Username:

Password:

Options:

- Reconnect on failure
- default route
- require-chap
- require-mschap
- require-mschap-v2
- require-mppe

Routing Option: Enable Routing Protocols through PPTP Client Connection

Operations:

Link Status: Disconnected

PPTP client settings screen

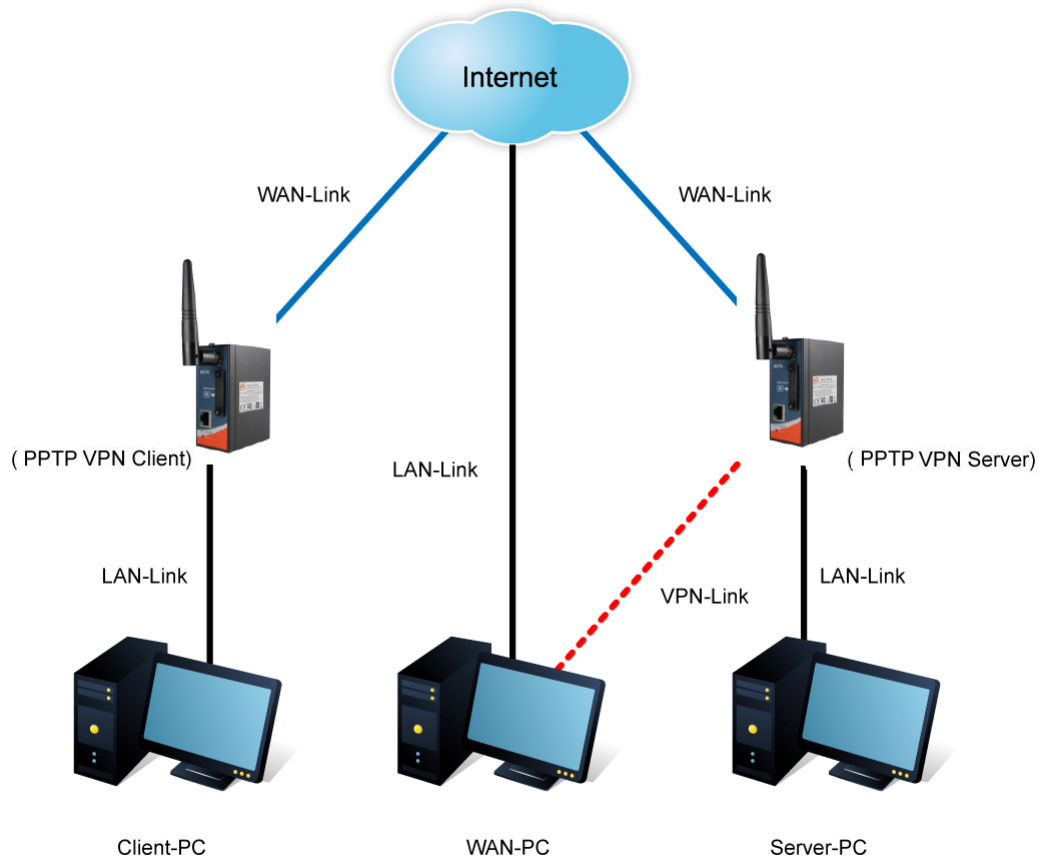

The following table describes the labels in this screen.

Label	Description
PPTP Client	Enable or disable PPTP Client.
Server IP/Hostname	Enter the server IP address or hostname.
Username/Password	Enter the username and password which is signed by PPTP server.
Option	<p>Reconnect on failure: Pitch on this option, it will be reconnect when the link is on failure.</p> <p>Require MPPE: Choose Enable Require MPPE (Microsoft Point-to-Point Encryption) to encrypt data across Point-to-Point Protocol (PPP) and Virtual Private Network links.</p>
Operations	Click "Connect" to link the server, if or not, you can click "Disconnect" to break off from the server.
Link Status	Show the status about the link.

Routing Protocol (Routing Setting)

This page shows the information of routing table. The initial state of the router connect to the WAN, it will be based on the outside networks to access the routing table automatically. You can refer the shows about the bellow page.

Current Routing Table:

Destination	Gateway	Subnet Mask	Metric	Interface
192.168.10.0	0.0.0.0	255.255.255.0	0	br0(LAN)
127.0.0.0	0.0.0.0	255.0.0.0	0	lo(LOOPBACK)

The table shows the normal routing table

1. Use Dynamic Routing

Use the dynamic routing, you should not choose "Disable" about the **RIPv1 & v2** in the routers.

Click "Apply", and you can see the more information in the **Current Routing Table**, which shows the network segment of the other router.

Advanced Setting --> Routing Protocol -> Routing Setting

Current Routing Table:

Destination	Gateway	Subnet Mask	Metric	Interface
192.168.10.0	0.0.0.0	255.255.255.0	0	br0(LAN)
127.0.0.0	0.0.0.0	255.0.0.0	0	lo(LOOPBACK)

Static Route Entry:

Destination	Gateway	Subnet Mask	Metric	Interface	Operations
<input type="text"/>	<input type="text"/>	<input type="text"/>	<input type="text"/>	WAN	<input type="button" value="Add"/>

Mode:

RIPv1 & v2:

Telnet Setting: Enable Disable

Port:

Password:

Routing setting screen

The following table describes the labels in this screen.

Label	Description
Current Routing Table	Show the current the routing information.
Static Router Entry	Not RIP and enter the right value in the textbox will be showing.
Mode	If you want to the PC in the router can visit the outside network, only choose the Gateway Mode ; if or not, you choose the Router Mode .
RIPv1 & v2	Choose "Disable" in the Static routing.
Telnet Setting	Only use in the Dynamic routing.

2. Use Static Routing

Use the Static routing, you should choose "Disable" about the **RIPv1 & v2** in the routers.

Click "Apply", and you can see the more information in the **Current Routing Table** and **Static Route Entry**, which shows the network segment of the other router.

Advanced Setting --> Routing Protocol -> Routing Setting

Current Routing Table:

Destination	Gateway	Subnet Mask	Metric	Interface
192.168.10.0	0.0.0.0	255.255.255.0	0	br0(LAN)
127.0.0.0	0.0.0.0	255.0.0.0	0	lo(LOOPBACK)

Static Route Entry:

Destination	Gateway	Subnet Mask	Metric	Interface	Operations
192.168.11.0	0.0.0.0	255.255.255.0	0	WAN	Commit Delete
<input type="text"/>	<input type="text"/>	<input type="text"/>	<input type="text"/>	WAN	Add

Mode:

RIPv1 & v2:

Telnet Setting: Enable Disable

Port:

Password:

Static route setting screen

Use the dynamic routing; it will have many ways such as RIP, OSPF.BGP. In this router, we use the RIP Protocol to finish the dynamic routing table.

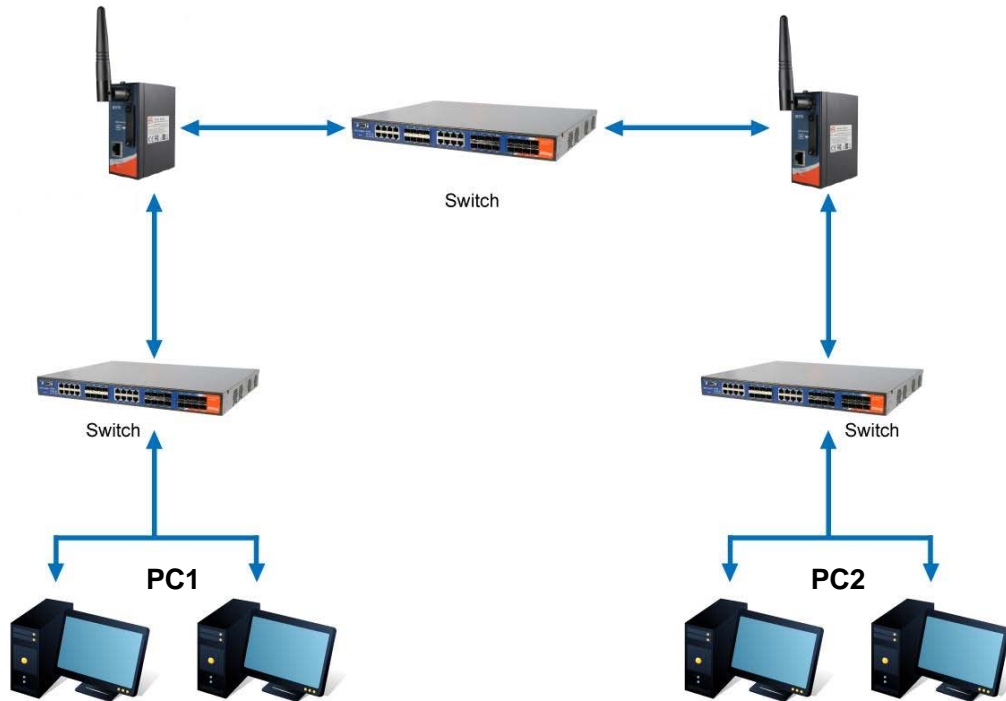

The Routing Topography

RIP, Routing Information Protocol, is a dynamic routing protocol used in local and wide area networks. As such it is classified as an interior gateway protocol (IGP) using the distance-vector routing algorithm.

After all settings, PC1 can visit PC2 which is different network segment of the PC1.

Miscellaneous DDNS

Dynamic Domain Name Server is to keep a domain name linked to a dynamic IP address.

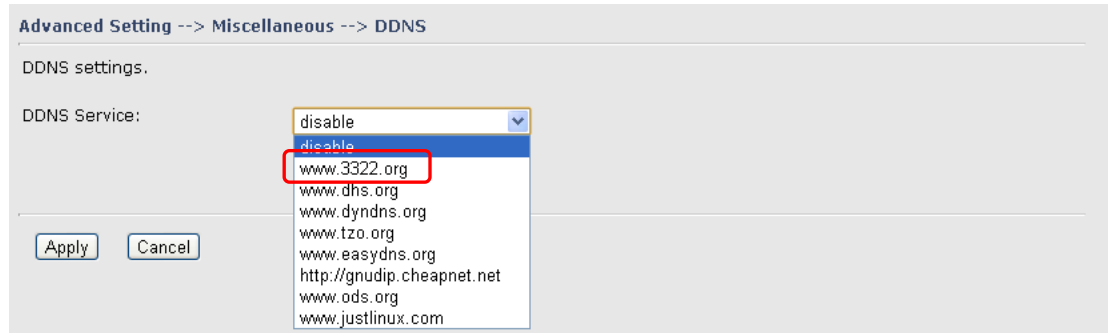

DDNS Screen

For example, Choose DDNS Service: www.3322.org and configure the following instructions:

The following table describes the labels in this screen.

Label	Description
User Name	Enter the user name for your DDNS account.
Password	Enter the password for your DDNS account.
Domain	Enter the domain names provided by your dynamic DNS service provider.
Mail Server	Enter the mail server if provided.
Use Wildcard	Check the box the enable wildcard option.

Miscellaneous SNMP

SNMP Settings

Advanced Setting --> Miscellaneous --> SNMP

SNMP settings

SNMP Agent: Enable Disable

SNMP Trap Server 1:

SNMP Trap Server 2:

SNMP Trap Server 3:

SNMP Trap Server 4:

Community:

SysLocation:

SysContact:

SNMP Settings

The following table describes the labels in this screen.

Label	Description
SNMP Agent	SNMP (Simple Network Management Protocol) agent communicates with the SNMP manager. The agent provides management information to the NMS by keeping track of various operational aspects of the system. Turn on to open this service and off to disable it.
SNMP Trap Server 1-4	Specify the IP address of trap server, which is the address to which SNMP trap messages are sent.
Community	Community is essentially password to establish trust between managers and agents. Normally "public" is used for read-write community.
SysLocation	Specify sysLocation string.
SysContact	Specify sysContact string.

5.3.3 System Tools

Date & Time

In this page, you can set the date & time of the device. The correct date & time will be helpful for logging of system events. A NTP (Network Time Protocol) client can be used to synchronize date & time with NTP server through internet.

System Tools --> Date & Time

Date/Time settings.

Local Date: Year Month Day

Local Time: Hour Minute Second

Time Zone:

NTP: Enable

NTP Server 1:

NTP Server 2: (optional)

Synchronise: at :

Date & Time Screen

The following table describes the labels in this screen.

Label	Description
Local Date	Set local date manually.
Local Time	Set local time manually.
Time Zone	Select the time zone manually
Get Current Date & Time from Browser	Click this button; you can set the time from your browser.
NTP	Enable or disable NTP function to synchronize time from the NTP server.
NTP Server 1	The primary NTP Server.
NTP Server 2	The secondary NTP Server.
Synchronize	This is the scheduled time when the NTP synchronization performed.

System Event

When the WAN Link Down is triggered, the notification procedure will be performed

System Tools --> System Event

WAN Link Down Alarm

Disable WAN Link Down Alarm

Enable WAN Link Down Alarm

Login Setting

At this page, the administrator can change the login name and password. The default name and password is **admin** and **admin**.

System Tools --> Login Setting

Login settings.

Old Login Name: admin

Old Password:

New Login Name:

New Password:

Confirm New Password:

Web Protocol: HTTP HTTPS

Port:

Login Setting Screen

The following table describes the labels in this screen.

Label	Description
Old Name	This field shows the old login name.
Old Password	Before making a new setting, you should provide the old password for verification. Acceptable characters of this field contains '0-9', 'a-z', 'A-Z' and must be between 0 to 15 characters in length. An empty password is also acceptable.
New Name	Enter a new login name. Acceptable characters of this field contains '0-9', 'a-z', 'A-Z' and must be between 1 to 15 characters in length. An empty name is not acceptable.

New Password	Enter a new login password. Acceptable characters of this field contains '0-9', 'a-z', 'A-Z' and must be between 0 to 15 characters in length.
Confirm New Password	Retype the password to confirm it. Acceptable inputs of this field contains '0-9', 'a-z', 'A-Z' and must be between 0 to 15 characters in length.
Web Protocol	Choose the web management page protocol. HTTP and HTTPS are both supported.
Port	Choose the web management page port number. For HTTP, default port is 80; For HTTPS, default port is 443.

HTTPS (HTTP over SSL) is a Web protocol which encrypts and decrypts user page requests as well as the pages that are returned by the Web server.

Router Restart

If you want restart the router through the **Warm Reset**, click **Restart Now** to restart the Wireless Router. Also, you can set a **Scheduling** time to make the router restart.

System Tools --> Router Restart

Router Restart Utility.

Scheduling: Enable

Restart at :

Router Restart Screen

Firmware Upgrade

System Tools --> Firmware Upgrade

Do NOT power off the router while upgrading!

Current Firmware Version: 1.0i

Firmware Upgrade Screen

Newer firmware may provide better performance or function extensions. To upgrade the new firmware, you need a firmware file which matches the model of this AP router. It will take several minutes to upload and update the firmware. After the upgrade is done successfully, reboot the router to utilized new firmware.

Important Notice: DO NOT POWER OFF THE ROUTER OR PRESS THE RESET BUTTON WHILE THE FIRMWARE IS BEING UPGRADED.

Save/Restore Configurations

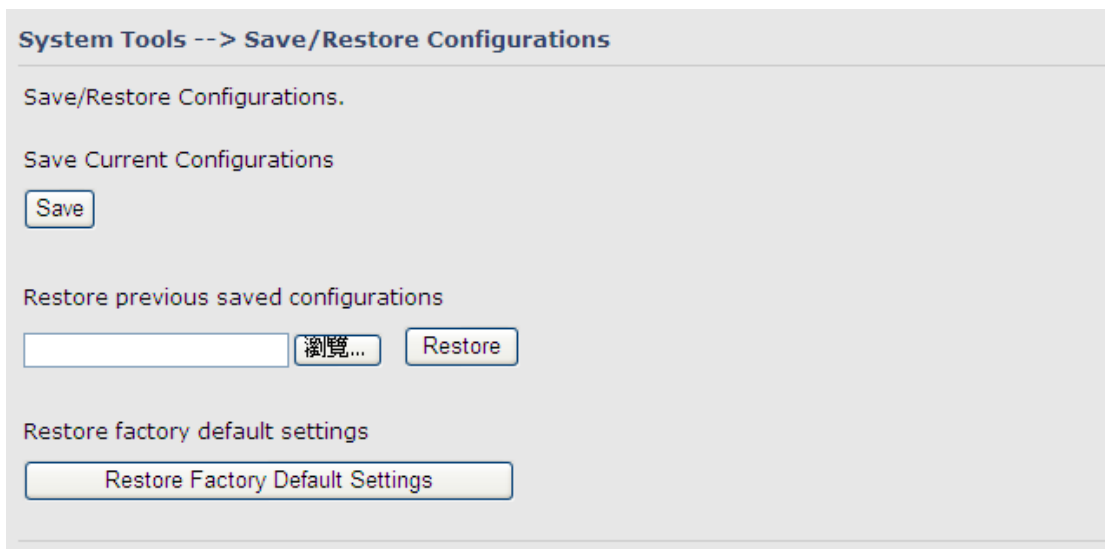

Save/Restore Configurations Screen

Save: The configuration file can be downloaded. (Internet Explorer user will need to click on the protection bar on top and click choose “download files”)

The following table describes the labels in this screen.

Label	Description
Download configuration	The current system settings can be saved as a file into your PC.
Upload configuration	The configuration can be restored to the router. To reload a system settings file, click on Browse to browse your local hard drive and locate the system settings file previously saved. Click Upload when you have selected the file.
Restore Default Settings	You may also reset the router to the factory settings by clicking on Restore Default Settings . The router will reboot to validate the default settings.

Remote management

Set the Remote Management to access the Router web pages from WAN side.

System Tools --> Remote Management

Set the Remote Management to access the Router web pages from WAN side.

Remote Management: Enable Disable

Management Port:

Permission: Any Host

Host with IP address:

Host within IP range: -

Miscellaneous (Ping)

System Tools --> Miscellaneous

Miscellaneous utilities.

Ping Test: Destination:

Ping Test Result:

Miscellaneous Screen

The Ping Test is used to send Ping packets to test if a computer whether it is on the Internet or test if the WAN connection is OK. Enter a domain or IP in the destination box and click Ping to test.

5.3.4 System Status

System Info

System Status --> System Info

System Info.

Model:	IR-710	
Model Description:	Industrial Cellular VPN router with 1x10/100Base-T(X)	
WAN:	Mode	Modem/3G
LAN:	IP Address	192.168.10.1
	Subnet Mask	255.255.255.0
	MTU	1500
	MAC Address	00:1E:94:01:21:0F
	DHCP Server	Enabled

System Info Screen

This page displays the details information for the router including model name, model description, firmware version, WAN, LAN settings.

System Log

System Status --> System Log

System log.

Log Option:	<input type="checkbox"/> DHCP Server	<input type="checkbox"/> Boot Message
	<input type="checkbox"/> NTP Client	<input type="checkbox"/> UPNP
	<input type="checkbox"/> Firewall	<input type="checkbox"/> Modem
	<input type="button" value="Select All"/> <input type="button" value="Deselect All"/> <input type="button" value="Save Option"/>	

System Log:

#	Date Time	Item	Content
---	-----------	------	---------

System Log Screen

The router keeps a running log of events and activities occurring on the router, several filters are provided for displaying related log entries.

Click the button '**Refresh**' to refresh the page.

Click the button '**Clear Logs**' to clear the log entries.



Traffic Statistics

System Status --> Traffic Statistics

Traffic statistics.

Interface	Send	Receive
LAN	592916 Bytes (1433 Packets)	178571 Bytes (1468 Packets)
WAN	0 Bytes (0 Packets)	0 Bytes (0 Packets)

Traffic Statistics Screen

This page displays the network traffic statistics for both received and transmitted packets through the Ethernet port and wireless connections.



Technical Specifications

ORing Router Model	IR-710	IR-711UB
Physical Ports		
10/100 Base-T(X) Ports in RJ45 Auto MDI/MDIX	1	
Sim Card Slot	1	
USB Host Port	1 x USB 2.0 Host Port	
Modem Support		
List		USB modems and ISDN adapters which support the Communication Device Class Abstract Control Model interface List of tested device Hummingbird huc56s (Conexant) Huawei E230 Simense HSDPA-180C Prolific 2303 + serial modem Quanta MUQ101 Sony Ericsson MD400/MD400g Sierra C885
Cellular Interface		
Cellular Standard	GSM / GPRS/ EGPRS/ EDGE / WCDMA / HSDPA / HSUPA	
Band Option	Dual-band : HSUPA 1900/2100 MHz Quad-band : GSM/GPRS/EDGE 850/900/1800/1900 MHz WCDMA/HSDPA 850/900/1900/2100 MHz	
LED Indicators		
Power Indicator	Green On: Power is on	
Status Indicator	Green: System status indication	
Fault Indicator	Red on : WAN connection link down	
WAN	Green on: Cellular modem link/act Green blinking: Cellular modem is transmitting data	
USB Indicator		Green on : USB Modem is present
Fault Contact		
Relay	Relay output to carry capacity of 1A at 24VDC	
Power		
Power Input	12-48VDC power input on terminal block	
Power Consumption	4.5W	3.3W
Physical Characteristics		
Enclosure	IP-30	
Dimension (W x D x H)	41(W)x70(D)x95(H) mm (1.61 x 2.75 x 3.74 inch.)	26.1(W)x70(D)x95(H) mm (1.03x2.76x3.74 inches)
Weight (g)	356g	190g
Environmental		



Storage Temperature	-40 to 85°C (-40 to 185°F)	
Operating Temperature	-10 to 55°C (14 to 131°F)	-20 to 70 °C(-4 to 158 °F)
Operating Humidity	5% to 95% Non-condensing	
Regulatory approvals		
EMI	FCC Part 15, CISPR (EN55022) class A	
EMS	EN61000-4-2 (ESD), EN61000-4-3 (RS), EN61000-4-4 (EFT), EN61000-4-5 (Surge), EN61000-4-6 (CS), EN61000-4-8, EN61000-4-11	
Warranty	5 years	